

IHRE EXPERTEN FÜR DIESELMOTORENTEILE MAN D0834... / D0836... COMMON RAIL
YOUR EXPERTS FOR DIESEL ENGINE PARTS MAN D0834... / D0836... COMMON RAIL
VOS EXPERTS EN PIÈCES MOTEURS D0834... / D0836... COMMON RAIL
SUS EXPERTOS EN MOTORES DIESEL PARA PIEZAS MAN D0834... / D0836... COMMON RAIL
ВАШИ ЭКСПЕРТЫ ПО ЗАПЧАСТЯМ К ДИЗЕЛЬНЫМ ДВИГАТЕЛЯМ MAN D0834... / D0836... COMMON RAIL

2015/16

MAN Dieselmotorenteile Common Rail

D0834... / D0836...

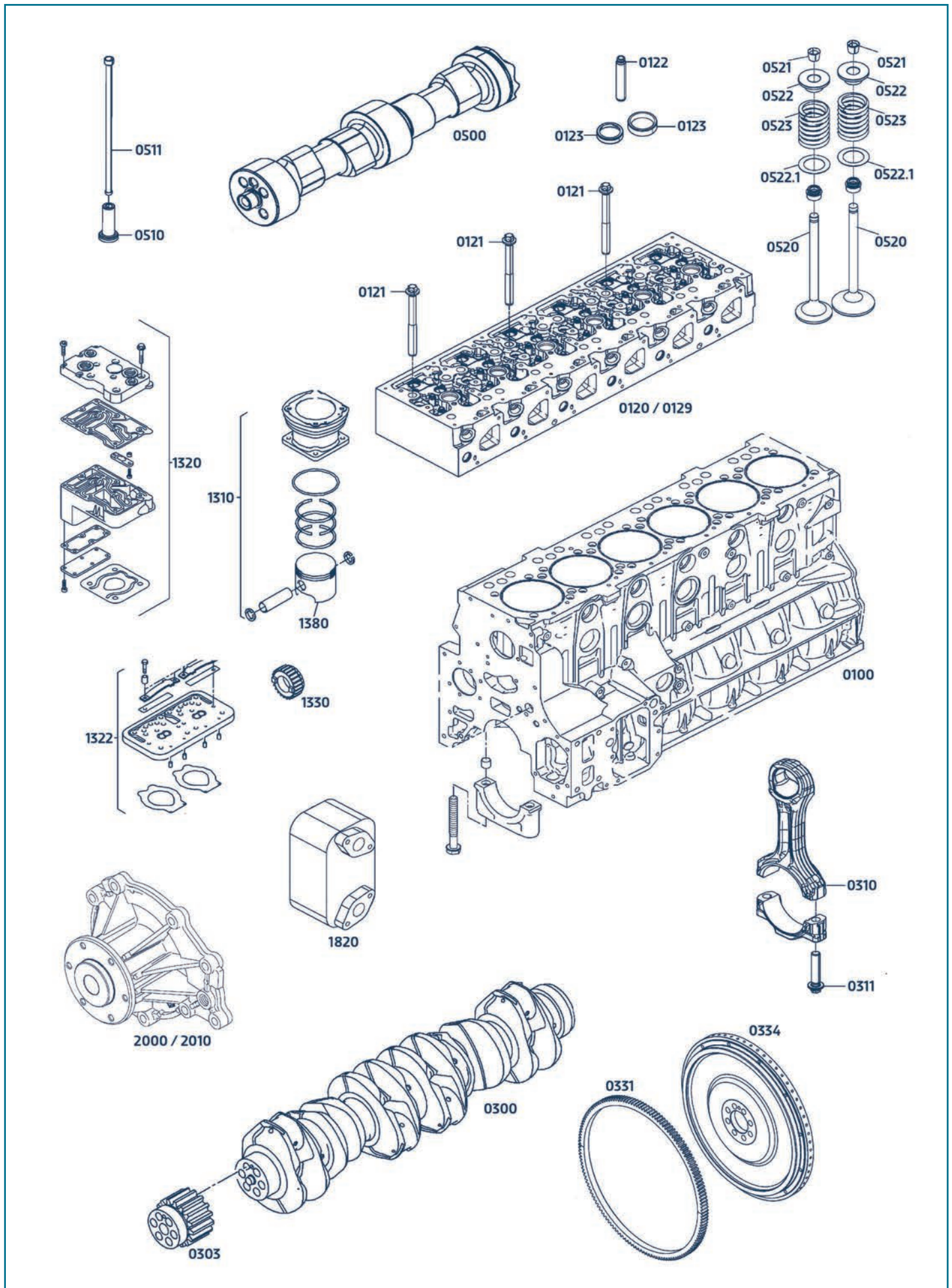

D0834... / D0836...

Pos. Nr. поз. Nr.	Motor Typ / Motor type Type Moteur / Tipo Motor тип мотора	Bemerkung / Comment Observation / Observaciones примечание	OE Germany Teile Nr. Part no. / Numéro Réf. / номер	Referenz / Reference Référence / Referencia ссылка
SHORTBLOCKS / SHORTBLOCKS / BLOCS EMBIELLÉS / MOTORES ALIGERADOS / ШОРТБЛОКИ				
Shortblock / shortblock / bloc embiellé / Motor 3/4 / шортблоки				
0109	D0834 LFL50-55/57 D0834 LOH40/50-53/60/61/63	ohne Zylinderkopf / without cylinder head sans culasse / sin culata без головок блока цилиндров	02 0109 083402	
0109	D0834 LFL50-55/57 D0834 LOH40/50-53/60/61/63	mit Zylinderkopf / with cylinder head avec culasse / con culata с головками блока цилиндров	02 0109 083403	
0109	D0836 LFG50 D0836 LFL50-55 D0836 LOH51-58/60-68	ohne Zylinderkopf / without cylinder head sans culasse / sin culata без головок блока цилиндров	02 0109 083602	
0109	D0836 LFG50 D0836 LFL50-55 D0836 LOH51-58/60-68	mit Zylinderkopf / with cylinder head avec culasse / con culata с головками блока цилиндров	02 0109 083603	
KURBELGEHÄUSE / CRANKCASES / BLOCS MOTEURS / BLOQUES / КАРТЕР				
Kurbelgehäuse / crankcase / bloc moteur / bloque / картер				
0100	D0834 LF01/02/06 D0834 LFL40/42/50-55/57/60-68/70/71/75 D0834 LOF01-04 D0834 LOH40/50-53/60/61/63		02 0100 083400	51.01100.6281 51.01100.6264
0100	D0836 LF13/41/43/44 D0836 LFG50 D0836 LFL50-55/60-65/69-71 D0836 LOH10/51-58/60-68		02 0100 083600	51.01100.6266
ZYLINDERKÖPFE / CYLINDER HEADS / CULASSES / CULATAS / ГОЛОВКИ БЛОКА ЦИЛИНДРОВ				
Zylinderkopf / cylinder head / culasse / culata / головка блока цилиндров				
0120	D0834 LF01/02/06 D0834 LFL40-42/50-55/57/60-68/70/71/75 D0834 LOF01-04 D0834 LOH40/50-53/60/61/63	ohne Ventile / without valves sans soupapes / sin válvulas без клапанов	02 0120 083400	51.03100.6397 51.03100.6274
0129	D0834 LF01/02/06 D0834 LFL40-42/50-55/57/60-68/70/71/75 D0834 LOF01-04 D0834 LOH40/50-53/60/61/63	mit Ventilen / with valves avec soupapes / con válvulas с клапанами	02 0129 083400	51.03100.6397
0120	D0836 LF13/41/43/44 D0836 LFG50 D0836 LFL40/41/44/50-55/60-65/69-71 D0836 LOH10/40/41/50-58/60-68 D0836 LUH40/41/50	ohne Ventile / without valves sans soupapes / sin válvulas без клапанов	02 0120 083600	51.03100.6273
0129	D0836 LF13/41/43/44 D0836 LFG50 D0836 LFL40/41/44/50-55/60-65/69-71 D0836 LOH10/40/41/50-58/60-68 D0836 LUH40/41/50	mit Ventilen / with valves avec soupapes / con válvulas с клапанами	02 0129 083600	51.03100.6273
Ventilfeder / valve spring / ressort de soupape / resorte de válvula / пружина клапана				
0523	D0834 LF01/02/06 D0834 LFL40-42/50-55/57/60-68/70/71/75 D0834 LOF01-04 D0834 LOH40/50-53/60/61/63 D0836 LF13/15/41/43/44 D0836 LFG50-51 D0836 LFL40/41/44/50-56/60-71/75-77 D0836 LOH10/11/40/41/50-58/60-68/70-76 D0836 LUH40/41/50	IN / EX	02 0523 080000	51.04102.0155
Ventilsitzring / valve seat insert / siège de soupape / asiento de válvula / кольцо седла клапана				
0123	D0834 LF01/02/06 D0834 LFL40-42/50-55/57/60-68/70/71/75 D0834 LOF01-04 D0834 LOH40/50-53/60-63 D0836 LF13/15/41/43/44 D0836 LFG 50-51 D0836 LFL40/41/44/50-56/60-71/75-77 D0836 LOH10/11/40/41/50-58/60-68/70-76 D0836 LUH40/41/50	IN A: 40 B: 30 C: 8,15	02 0123 083000	51.03203.0382

Pos. Nr. поз. Nr.	Motor Typ / Motor type Type Moteur / Tipo Motor тип мотора	Bemerkung / Comment Observation / Observaciones примечание	OE Germany Teile Nr. Part no. / Numéro Réf. / номер	Referenz / Reference Référence / Referencia ссылка
Ventilsitzring / valve seat insert / siège de soupape / asiento de válvula / кольцо седла клапана				
0123	D0834 LF01/02/06 D0834 LFL40-42/50-55/57/60-68/70/71/75 D0834 LOF01-04 D0834 LOH40/50-53/60-63 D0836 LF13/15/41/43/44 D0836 LFG 50-51 D0836 LFL40/41/44/50-56/60-71/75-77 D0836 LOH10/11/40/41/50-58/60-68/70-76 D0836 LUH40/41/50	EX A: 36 B: 28,5 C: 6,4	02 0123 083001	51.03203.0386 51.03203.0409
Federteller / spring cap / coupelle de ressort / plato resorte / тарелка пружины				
0522	D0834 LF01/02/06 D0834 LFL40-42/50-55/57/60-68/70/71/75 D0834 LOF01-04 D0834 LOH40/50-53/60/61/63 D0836 LF13/15/41/43/44 D0836 LFG50-51 D0836 LFL40/41/44/50-56/60-71/75-77 D0836 LOH10/11/40/41/50-58/60-68/70-76 D0836 LUH40/41/50	Federteller / spring cap coupelle de ressort / plato resorte тарелка пружины	02 0522 080000	51.04103.0105 51.04103.0109
0522.1	D0834 LF01/02/06 D0834 LFL40-42/50-55/57/60-68/70/71/75 D0834 LOF01-04 D0834 LOH40/50-53/60/61/63 D0836 LF13/15/41/43/44 D0836 LFG50-51 D0836 LFL40/41/44/50-56/60-71/75-77 D0836 LOH10/11/40/41/50-58/60-68/70-76 D0836 LUH40/41/50	Scheibe / disk rondelle / disco диск	208342	51.90701.0233 51.90701.0236
Ventilkegelstück / valve cone / demi-cone de soupape / seguro de válvula / сужарь клапана				
0521	D0834 LF01/02/06 D0834 LFL40-42/50-55/57/60-68/70/71/75 D0834 LOF01-04 D0834 LOH40/50-53/60/61/63 D0836 LF13/15/41/43/44 D0836 LFG50-51 D0836 LFL40/41/44/50-56/60-71/75-77 D0836 LOH10/11/40/41/50-58/60-68/70-76 D0836 LUH40/41/50		02 0521 080000	51.04104.0033 51.04104.0032
Ventilführung / valve guide / guide de soupape / guia de válvula / направляющая втулка клапана				
0122	D0834 LF01/02/06 D0834 LFL40-42/50-55/57/60-68/70/71/75 D0834 LOH40/50-53/60-63 D0836 LF13/15/41/43/44 D0836 LFL40/41/44/50-56/60-71/75-77 D0836 LFG 50-51 D0836 LOH40/41/50-58/60-68/70-76 D0836 LUH40/41/50	IN / EX A: 13 B: 7 L: 60	02 0122 083000	51.03201.0122 51.03201.1084
Ventil / valve / soupape / válvula / клапан				
0520	D0834 LFL40-42/50-55/57/60-68/70/71/75 D0834 LOH40/50-53/60/61/63 D0836 LF13/15/41/43/44 D0836 LFG50-51 D0836 LFL40/41/44/50-56/60-71/75-77 D0836 LOH40/41/50-58/60-68/70-76 D0836 LUH40/41/50	IN	02 0520 083000	51.04101.0537 51.04101.0515 51.04101.0516
0520	D0834 LFL40-42/50-55/57/60-68/70/71/75 D0834 LOH40/50-53/60/61/63 D0836 LF13/15/41/43/44 D0836 LFG50-51 D0836 LFL40/41/44/50-56/60-71/75-77 D0836 LOH40/41/50-58/60-68/70-76 D0836 LUH40/41/50	EX	02 0520 083001	51.04101.0538
Zylinderkopfschraube / cylinder head bolt / vis de culasse / tornillo culata / болт головки блока цилиндра				
0121	D0834 LF01/02 D0834 LFL 40-42/50-55/57/60-65 D0834 LOF01/02 D0834 LOH40/50-53/60/61 D0836 LF13/41/43/44 D0836 LFG50 D0836 LFL01-06/40/41/44/50-55/60-65/69-71 D0836 LOH10/40/41/50-58/60-68 D0836 LUH40/41/50	M14 x 2 x 152 mm	02 0121 083600	51.90020.0465 51.90020.0383

D0834... / D0836...

Pos. Nr. поз. Nr.	Motor Typ / Motor type Type Moteur / Tipo Motor тип мотора	Bemerkung / Comment Observation / Observaciones примечание	OE Germany Teile Nr. Part no. / Numéro Réf. / номер	Referenz / Reference Référence / Referencia ссылка
KURBELWELLEN / CRANKSHAFTS / VILEBERQUINS / CIGÜEÑALES / КОЛЕНЧАТЫЙ ВАЛ				
Kurbelwelle / crankshaft / vileberquin / cigüeñal / коленчатый вал				
0300	D0834 LF01/02/06 D0834 LFL40/42/50-55/57/60-68/70/71/75 D0834 LOF01-04 D0834 LOH40/50-53/60/61/63	ohne Lager / without bearings sans coussinets / sin cojinetes без вкладышей	02 0300 083401	51.02100.6028
0300	D0836 LF13/15/41/43/44 D0836 LFG50-51 D0836 LFL40/41/44/50-56/60-71/75/77 D0836 LOH10/11/40/41/50-58/60-68/70-76 E0836 LOH	ohne Lager / without bearings sans coussinets / sin cojinetes без вкладышей	02 0300 083601	51.02100.6022 51.02100.9022 51.02100.6068
Schwungrad / flywheel / volant moteur / volante / маховик				
0334	D0834 LFL40-42/50-55/57/60-68/70/71/75 D0834 LOH40/50-53/60-63 D0836 LFL40/41/44		02 0330 083400	51.02301.5267 51.02301.9267
Kurbelwellenrad / crankshaft timing gear / pignon de vilebrequin / engranaje cigüeñal / распределительная шестерня коленчатого вала				
0303	D0834 LF01/02/06 D0834 LFL40-42/50-55/57/60-68/70/71/75 D0834 LOF01-04 D0834 LOH40/50-53/60/61/63 D0836 LF13/15/41/43/44 D0836 LFG50-51 D0836 LFL13/40/41/44/50-56/60-71/75-77 D0836 LOH10/11/40/41/50-58/60-68/70-76 D0836 LUH40/41/50 E0836 LOH		02 0303 080000	51.02115.0210 51.02115.0251
Zahnkranz / ring gear / couronne de démarrage / corona dentada / венец маховика				
0331	D0224... D0226... D0824... D0826... D0834 LFL01-04/40-42/50-55/57 D0834 LFL60-68/70/71/75 D0834 LOH01-03/40/50-53/60/61/63 D0836 LF01-05 D0836 LFL01-06/40/41/44 D0836 LOH01-04 G0826 DOH		02 0331 082602	51.02310.0087
PLEUELSTANGEN / CONNECTING RODS / BIELLES / BIELAS / ШАТУН				
Pleuelstange / connecting rod / bielle / biela / шатун				
0310	D0834 LF01/02/06 D0834 LFL 50-55/57/60-68/70/71/75 D0834 LOF01-04 D0834 LOH40/50-53/60/61/63 D0836 LF13/15/41/43/44 D0836 LFG50-51/ D0836 LFL50-56/60-71/75-77 D0836 LOH10/11/51-58/60-68/70-76 E0836 LOH	D1: 44 D2: 74 L: 196 Euro 4/5 gecrackt / cracked crackée / craqueada с разломом	02 0310 083401	51.02400.6068 51.02400.6045
Pleuelschraube / big end bolt / vis de bielle / tornillo biela / болт шатуна				
0311	D0834 LF01/02 D0834 LFL01-04/40-42/50-55/57/60-65 D0834 LOF01/02 D0834 LOH01-03/10/40/50-53/60/61 D0836 LF01-05/13/41/43/44 D0836 LFG01/50 D0836 LFL01-06/10/40/41/44/50-55/60-65/69-71 D0836 LOH/01-04/40/41/50-58/60-68 D0836 LUH01/02/40/41/50	M11 x 1,5 x 60 mm	02 0311 083600	51.90490.0028

Pos. Nr. поз. Nr.	Motor Typ / Motor type Type Moteur / Tipo Motor тип мотора	Bemerkung / Comment Observation / Observaciones примечание	OE Germany Teile Nr. Part no. / Numéro Réf. / номер	Referenz / Reference Référence / Referencia ссылка
NOCKENWELLEN / CAMSHAFTS / ARBRES À CAMES / ARBOLS DE LEVAS / РАСПРЕДЕЛИТЕЛЬНЫЙ ВАЛ				
Nockenwelle / camshaft / arbre à cames / arbol de levas / распределительный вал				
0500	D0834 LF01/0206 D0834 LFL40/42/50-55/57/60-68/70/71/75 D0834 LOF01-04/40/50-53/60-63		02 0500 083402	51.04401.6391
0500	D0836 LF13/41/43/44 D0836 LFG50 D0836 LFL40/41/44/50-55/60-65/69-71 D0836 LOH10/40/41/50-58/60-68 D0836 LUH40/41/50		02 0500 083602	51.04401.6396 51.04401.0789
Ventilstößel / valve tappet / poussoir / taque de válvula / толкатель клапана				
0510	D0826 LFL03/06-10 D0834 LF01/02 D0834 LFL40-42/50-55/57/60-65 D0834 LOF01/02 D0834 LOH 01-03/10/50-53/60/61 D0836 LF13/41/43/44 D0836 LFG50 D0836 LFL01-06/40/41/44/50-55/60-65/69-71 D0836 LOH01-04/10/40/41/50-58/60-68 D0836 LUH01/02/40/41/50		02 0510 083600	51.04301.0121 51.04301.0131
Stößelstange / push rod / tige de culbuteur / varilla de empuje / штанга толкателя				
0511	D0834 LFL40-42/50-55/57/60-68/70/71/75 D0834 LOH40/50-53/60/61/63 D0836 LF13/15/41/43/44 D0836 LFG50-51 D0836 LFL40/41/44/50-56/60-71/75-77 D0836 LOH10/11/40/41/50-58/60-68/70-76 D0836 LUH40/41/50		02 0511 080001	51.04302.0062
KOMPRESSOREN / COMPRESSORS / COMPRESSEURS / COMPRESORES / КОМПРЕССОРЫ				
Antriebsrad / drive gear / pignon / rueda motriz / ведущая шестерня				
1330	D0834 LF01/02/06 D0834 LFL40/41/42/50-55/57/60-68/70/71/75 D0834 LOF01-04 D0834 LOH40/50/51/52/53/60/61/63 D0836 LF13/15/41/43/44 D0836 LFG50-51/60-71/75-77 D0836 LFL13/40/41/44/50-56 D0836 LOH10/11/40/41/50-58/60-68/70-76 E0836 LOH		02 1330 080000	51.54210.0205 51.54210.0164
Kolben-Zylinder Assembly / piston-cylinder kit / cylindrée / conjunto / цилиндро-поршневая группа				
1310	D0826 LUH01-06/08/10/12/13/213 D0836 LOH01-04/40/41/50-58/60-68/70-76 D2866 LOH27-29/32-35/37-40/50-51 E0836 LOH	Ø 88 mm luftgekühlt / air-cooled refroidi à air / enfriado por aire охлаждаемый воздухом	02 1310 080000	51.54119.6003 51.54105.6019
Kolben für Kompressoren / piston for compressor / piston pour compresseur / piston para compresor / поршень в сборе для компрессоров				
1380	D0826... D0834 LF01/02/06 D0834 LFL01-04/40-42/50-55/57/60-68/70/71/75 D0834 LOF01-04 D0834 LOH01-03/40/50-53/60/61/63 D0836 LF01-05/13/15/41/43/44 D0836 LFG01/50-51 D0836 LFL01-06/13/16/40/41/44/50-56/60-71/75-77 D0836 LOH 01-04/10/11/40/41/50-58/60-68/70-76 E0836 LOH	nur Kolben / piston only piston seul / solo piston поршень Ø 85 mm	02 1380 080000	51.54119.6002 81.54119.6040
Zylinderkopf für Kompressoren / cylinder head for compressor / culasse pour compresseur / culata para compresor / головка блока цилиндров для компрессоров				
1320	D0834 LF01/02/06 D0834 LFL01-04/40-42/50-55/57/60-68/70/71/75 D0834 LOF 01-04 D0834 LOH01-03/40/50-53/60/61/63 D0836 LF01-05/13/15/41/43/44 D0836 LFG01/50-51 D0836 LFL01-06/13/16/40/41/44/50-56/60-71/75-77 D0836 LOH01-04/10/11/40/41/50-58/60-68/70-76 E0836 LOH	für Kompressor 1-Zylinder for 1-cylinder compressor pour compresseur mono-cylindre para compresor de 1 cilindro для одноцилиндрового компрессора Ø 85 mm mit Ventilplatte / with valve plate avec plaque à clapet / con placa de válvula с пластиной клапана	02 1320 080003	51.54114.6082

D0834... / D0836...

Pos. Nr. поз. Nr.	Motor Typ / Motor type Type Moteur / Tipo Motor тип мотора	Bemerkung / Comment Observation / Observaciones примечание	OE Germany Teile Nr. Part no. / Numéro Réf. / номер	Referenz / Reference Référence / Referencia ссылка
Reparatursatz für Kompressoren / repair kit for compressors / kit réparation compresseurs / juego reparación para compresores / ремонтный комплект				
1322	D0834 LF01/02/06 D0834 LFL01-04/40-42/50-55/57/60-68/70/71/75 D0834 LOF 01-04 D0834 LOH01-03/40/50-53/60/61/63 D0836 LF01-05/13/15/41/43/44 D0836 LFG01/50-51 D0836 LFL01-06/13/16/40/41/44/50-56/60-71/75-77 D0836 LOH01-04/10/11/40/41/50-58/60-68/70-76 E0836 LOH	für Kompressor 1-Zylinder for 1-cylinder compressor pour compresseur mono-cylindre para compresor de 1 cilindro для одноцилиндрового компрессора Ø 85 mm Dichtungssatz zu / gasket-set for pochette de joints pour / juego de juntas para набор прокладок для 02 1320 080003 51.54114.6082	02 1322 080003	51.54100.6042
1322	D0826 LUH/01-06/08/10/12/13/213 D0836 LOH01-04/40/41/50-58/60-68/70-76 D2866 LOH27-29/32-35/37-40/50-51 E0836 LOH	Ventilplatte / valve plate plaque à clapet / placa de válvula пластина клапана für Kompressor 2-Zylinder for 2-cylinders compressor pour compresseur bi-cylindre para compresor de 2 cilindros для компрессора с 2-мя цилиндрами 51.54100.7069,LK4939 Ø 88 mm luftgekühlt / air-cooled refroidi à air / enfriado por aire охлаждаемый воздухом zu / to pour / para для 02 1320 080000	02 1322 080000	81.54124.6029 51.54116.6000
1322	D0826 LUH/01-06/08/10/12/13/213 D0836 LOH01-04/40/41/50-58/60-68/70-76 D2866 LOH27-29/32-35/37-40/50-51 E0836 LOH	für Kompressor 2-Zylinder for 2-cylinders compressor pour compresseur bi-cylindre para compresor de 2 cilindros для компрессора с 2-мя цилиндрами Ø 85 mm Dichtungssatz zu / gasket-set for pochette de joints pour / juego de juntas para набор прокладок для 02 1320 080001 81.54114.6022	02 1322 080001	81.54124.6032
ÖLKÜHLER / OIL COOLERS / RÉFROIDISSEURS D'HUILE / ENFRIADORES DE ACEITE / МАСЛЯНЫЙ РАДИАТОР				
Ölkühler / Oil cooler / refroidisseur d'huile / enfriador de aceite / масляный радиатор				
1820	D0834 LF01/02/06 D0834 LFL01-04/40-42/50-55/57/60-68/70/71/75 D0834 LOF 01-04 D0834 LOH40/50-53/60/61/63 D0836 LF01-05/13/15/41/43/44 D0836 LFG01/50-51 D0836 LFL01-06/40/41/44/50-56/60-71/75-77 D0836 LOH40/41/50-58/60-68/70-76		209331	51.05601.0179 51.05601.0173 51.05601.0159
1820	D0824... D0826... D0834 LOH01-05 D0836 LF01-05 D0836 LFG01 D0836 LFL01-06/40/41/44 D0836 LOH01-04/40/41/50-58/60-68/70-76 D0836 LUH01/02/40/41/50		02 1820 080000	51.05601.0107

Pos. Nr. поз. Nr.	Motor Typ / Motor type Type Moteur / Tipo Motor тип мотора	Bemerkung / Comment Observation / Observaciones примечание	OE Germany Teile Nr. Part no. / Numéro Réf. / номер	Referenz / Reference Référence / Referencia ссылка
WASSERPUMPEN / WATER PUMPS / POMPES À EAU / BOMBAS DE AGUA / ВОДЯНОЙ НАСОС				
Wasserpumpe / water pump / pompe à eau / bomba de agua / водяной насос				
2000	D0834 LFL01/02 D0834 LFL 40-42/50-55/57/60-65 D0834 LOF01/02 D0836 LF13/41/43/44 D0836 LFL40/41/44/50-55/60-65/69-71 D0836 LOH40/41/50	Flügelrad / impeller turbine / impulsor крыльчатка Ø 135 mm	02 2000 083000	51.06500.6679
2000	D0834 LFL50-55/57 D0834 LOH40/50-53/60/61 D0836 LFG50 D0836 LFL50-55 D0836 LOH51-58/60-68	Flügelrad / impeller turbine / impulsor крыльчатка Ø 135 mm	02 2000 083001	51.06500.6680 51.06500.6651 51.06500.9651 51.06500.7079
2000	D0834 LFL60-68/70/71/75 D0834 LOH 40/50-53/60/61/63 D0836 LFL60-71/75-77	Flügelrad / impeller turbine / impulsor крыльчатка Ø 135 mm	02 2000 083002	51.06500.6701 51.06500.9701 51.06500.6691
2000	D0836 LOH51-58/60-68	Flügelrad / impeller turbine / impulsor крыльчатка Ø 135 mm	02 2000 083600	51.06500.6673
2000	D0836 LFL60-65/69-71	Flügelrad / impeller turbine / impulsor крыльчатка Ø 135 mm	02 2000 083601	51.06500.6674
2000	D0834 LFL01-04 D0834 LOH01-03 D0836 LFL01-05 D0836 LFL01-06 D0836 LOH01-04 D0836 LFG01	mit zusätzlicher Nut im Flansch with additional flute in the flange avec rainure supplémentaire dans bride con lengüeta adicional en la brida с дополнительным пазом во фланце Flügelrad / impeller turbine / rueda de aletas крыльчатка Ø 125 mm	02 2000 083602	51.06500.6669 51.06500.6606 51.06500.9606 51.06500.6612
2000	D0836 LUH01/02/40/41/50	Flügelrad / impeller turbine / impulsor крыльчатка Ø 136 mm	02 2000 083603	51.06500.6587
Reparatursatz für Wasserpumpen / repair kit for water pumps / kit réparation pompes à eau / juego reparación bombas de agua / ремонтный комплект для водяного насоса				
2010	D0834 LFL01/02 D0834 LFL 40-42/50-55/57/60-65 D0834 LOH40/50-53/60/61 D0834 LOF01/02 D0836 LF13/41/43/44 D0836 LFL40/41/44/50-55/60-65/69-71 D0836 LFG50 D0836 LOH40/41/50-58/60-68	für Wasserpumpe / for water pump pour pompe à eau / para bomba de agua для водяных насосов 02 2000 083000 51.06500.6679 02 2000 083001 51.06500.6680 02 2000 206601 51.06500.6646 Flügelrad / impeller turbine / impulsor крыльчатка Ø 135 mm	02 2010 080000	
2010	D0826... D0834 LFL01/02/06 D0834 LFL01-04/40-42/50-55/57/60-68/70/71/75 D0834 LOF01-04 D0834 LOH01-03/40/50-53/60/61/63 D0836 LFL01-05/13/15/41/43/44 D0836 LFG01/50-51 D0836 LFL01-06/13/16/40/41/44/50-56/60-71/75-77 D0836 LOH 01-04/10/11/40/41/50-58/60-68/70-76 E0836 LOH	für Wasserpumpe / for water pump por pompe à eau / para bomba de agua для водяных насосов 02 2000 083603 51.06500.6587 Flügelrad / impeller turbine / impulsor крыльчатка Ø 136 mm	02 2010 080001	

D0834... / D0836...

Pos. Nr. поз. Nr.	Motor Typ / Motor type Type Moteur / Tipo Motor тип мотора	Bemerkung / Comment Observation / Observaciones примечание	OE Germany Teile Nr. Part no. / Numéro Réf. / номер	Referenz / Reference Référence / Referencia ссылка
SHORTBLOCKS / SHORTBLOCKS / BLOCS EMBIELLÉS / MOTORES ALIGERADOS / ШОРТБЛОКИ				
<i>Shortblock / shortblock / bloc embiellé / motor aligerado / шортблоки</i>				
0109	D0834 LFL50-55/57 D0834 LOH40/50-53/60/61/63	ohne Zylinderkopf / without cylinder head sans culasse / sin culata без головок блока цилиндров	02 0109 083402	
0109	D0836 LFG50 D0836 LFL50-55 D0836 LOH51-58/60-68	ohne Zylinderkopf / without cylinder head sans culasse / sin culata без головок блока цилиндров	02 0109 083602	

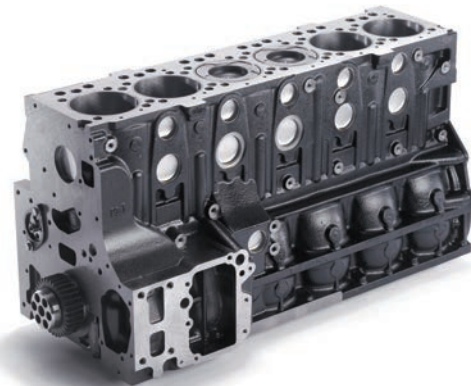
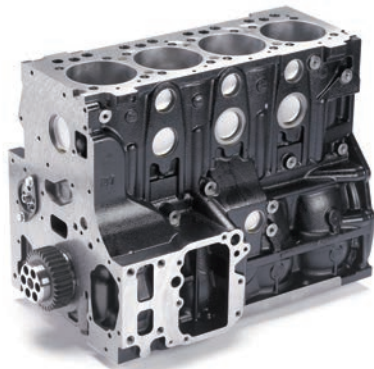

Pos. Nr. поз. Nr.	Motor Typ / Motor type Type Moteur / Tipo Motor тип мотора	Bemerkung / Comment Observation / Observaciones примечание	OE Germany Teile Nr. Part no. / Numéro Réf. / номер	Referenz / Reference Référence / Referencia ссылка
SHORTBLOCKS / SHORTBLOCKS / BLOCS EMBIELLÉS / MOTORES ALIGERADOS / ШОРТБЛОКИ				
<i>Shortblock / shortblock / bloc embiellé / motor 3/4 / шортблоки</i>				
0109	D0834 LFL50-55/57 D0834 LOH40/50-53/60/61/63	mit Zylinderkopf / with cylinder head avec culasse / con culata с головками блока цилиндров	02 0109 083403	
0109	D0836 LFG50 D0836 LFL50-55 D0836 LOH51-58/60-68	mit Zylinderkopf / with cylinder head avec culasse / con culata с головками блока цилиндров	02 0109 083603	

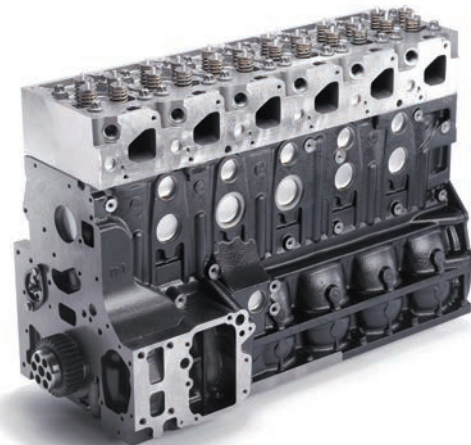
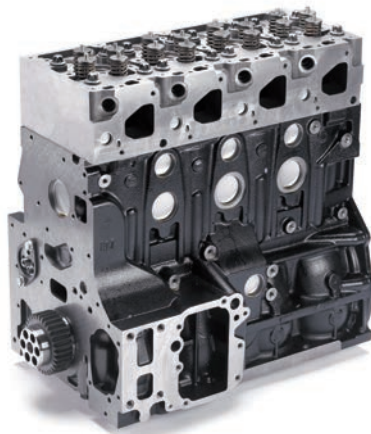

Pos. Nr. поз. Nr.	Motor Typ / Motor type Type Moteur / Tipo Motor тип мотора	Bemerkung / Comment Observation / Observaciones примечание	OE Germany Teile Nr. Part no. / Numéro Réf. / номер	Referenz / Reference Référence / Referencia ссылка
ZYLINDERKÖPFE / CYLINDER HEADS / CULASSES / CULATAS / ГОЛОВКИ БЛОКА ЦИЛИНДРОВ				
<i>Zylinderkopf/ cylinder head / culasse / culata / головка блока цилиндров</i>				
0120	D0834 LF01/02/06 D0834 LFL40-42/50-55/57/60-68/70/71/75 D0834 LOF01-04 D0834 LOH40/50-53/60/61/63	ohne Ventile / without valves sans soupapes / sin válvulas без клапанов	02 0120 083400	51.03100.6397 51.03100.6274
0120	D0836 LF13/41/43/44 D0836 LFG50 D0836 LFL40/41/44/50-55/60-65/69-71 D0836 LOH10/40/41/50-58/60-68 D0836 LUH40/41/50	ohne Ventile / without valves sans soupapes / sin válvulas без клапанов	02 0120 083600	51.03100.6273

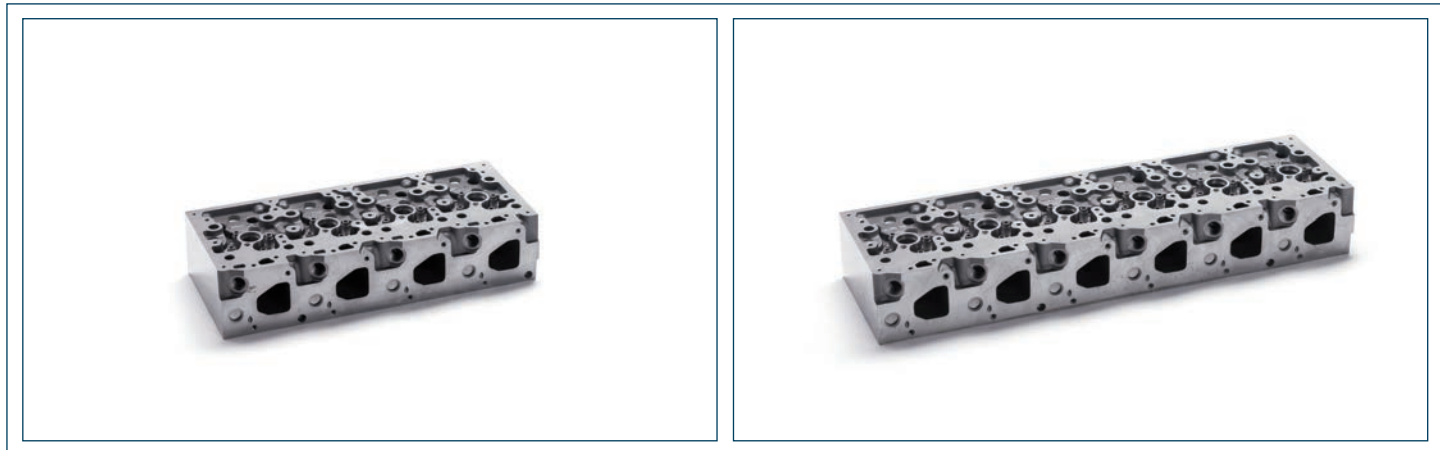

Pos. Nr. поз. Nr.	Motor Typ / Motor type Type Moteur / Tipo Motor тип мотора	Bemerkung / Comment Observation / Observaciones примечание	OE Germany Teile Nr. Part no. / Numéro Réf. / номер	Referenz / Reference Référence / Referencia ссылка
ZYLINDERKÖPFE / CYLINDER HEADS / CULASSES / CULATAS / ГОЛОВКИ БЛОКА ЦИЛИНДРОВ				
<i>Zylinderkopf/ cylinder head / culasse / culata / головка блока цилиндров</i>				
0129	D0834 LF01/02/06 D0834 LFL40-42/50-55/57/60-68/70/71/75 D0834 LOF01-04 D0834 LOH40/50-53/60/61/63	mit Ventilen / with valves avec soupapes / con válvulas с клапанами	02 0129 083400	51.03100.6397
0129	D0836 LF13/41/43/44 D0836 LFG50 D0836 LFL40/41/44/50-55/60-65/69-71 D0836 LOH10/40/41/50-58/60-68 D0836 LUH40/41/50	mit Ventilen / with valves avec soupapes / con válvulas с клапанами	02 0129 083600	51.03100.6273



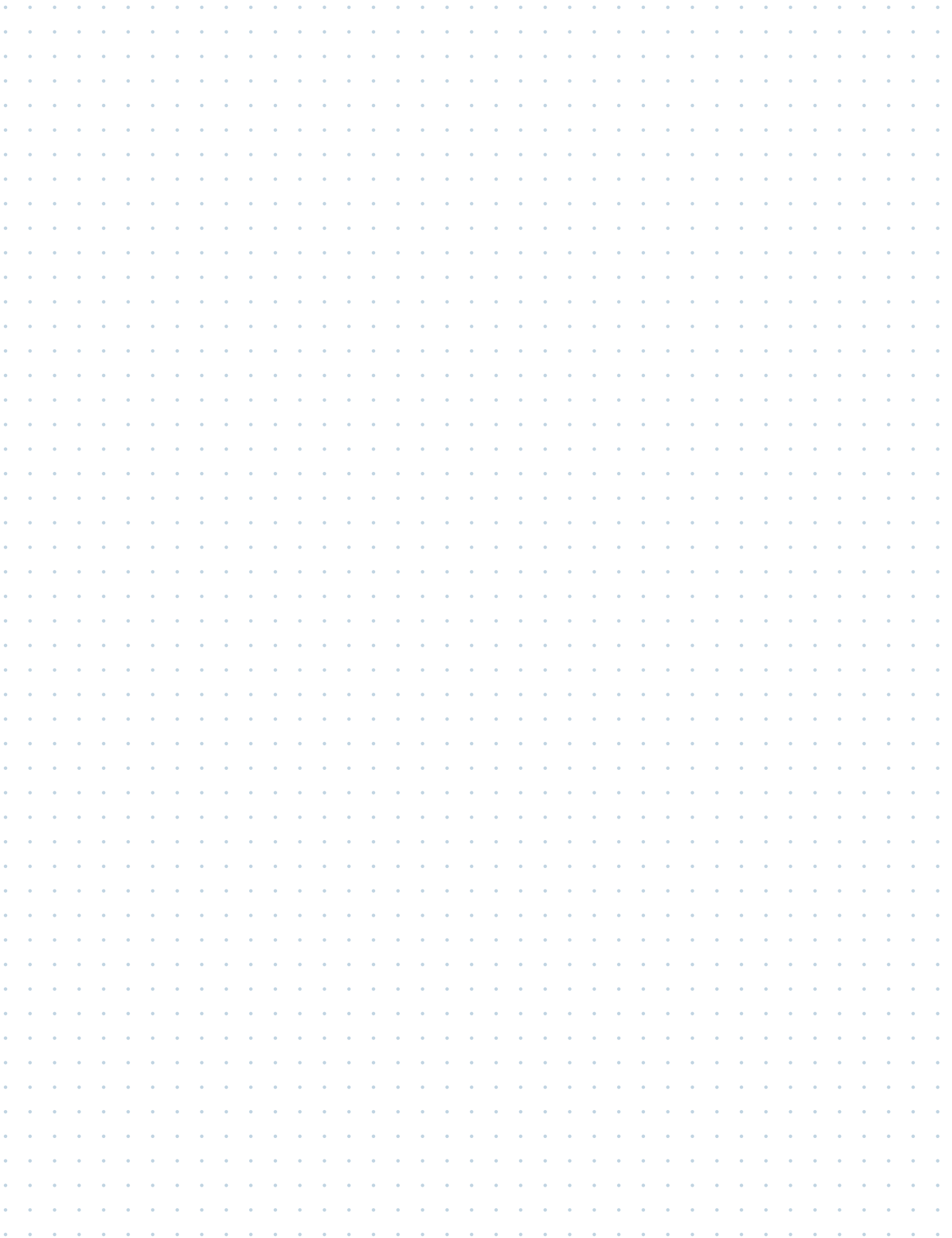

HERAUSGEBER / PUBLISHERS:

OE Germany Handels GmbH
Fritz-Müller-Straße 100-104
73730 Esslingen am Neckar
Germany

Phone +49 (0) 711 627698-0
Fax +49 (0) 711 627698-51

info@oe-germany.de
www.oe-germany.de

Sitz der Gesellschaft / Headquarters: Esslingen am Neckar
Amtsgericht Stuttgart / Stuttgart District Court: HRB 730378
Umsatzsteuer-Identifikationsnummer gemäß § 27 a / International VAT ID No. acc. to § 27 a: DE 266 137 673
Geschäftsführerin / Managing Director: Dr. Olga Schröder

Verantwortlich für den Inhalt / Responsible for contents: OE Germany Handels GmbH

Design & Realisation / Design & implementation:
Zuweso GmbH, Stuttgart

ALLGEMEINE INFORMATIONEN:

Es gelten unsere Allgemeinen Geschäftsbedingungen, die unter www.oe-germany.de veröffentlicht sind oder Ihnen auf Anfrage vorgelegt werden können.

Bezeichnungen, Original-Teilenummern, Motorentypen, Fahrzeugdaten oder andere Daten bezüglich Motoren-, Fahrzeug- oder anderen Herstellern werden ausschließlich zu internen Vergleichszwecken aufgeführt.

GENERAL INFORMATION:

Our General Terms and Conditions of Business published under www.oe-germany.de shall apply and will be supplied on request.

Designations, original part numbers, engine types, vehicle characteristics or other data relating to engine, vehicle or other manufacturers are exclusively quoted for internal purposes of comparison.

INFORMATIONS GÉNÉRALES:

Nos conditions générales de vente sont applicables, vous les trouvez publiées sous www.oe-germany.de ou nous pouvons vous les présenter sur simple demande.

Les appellations, références de pièces d'origine, types moteurs, types véhicules ou toute autre information concernant les moteurs, les véhicules ou les fabricants sont uniquement indiqués à des fins de comparaisons internes.

INFORMACIÓN GENERAL:

Nuestros términos y condiciones generales de contratación publicadas bajo www.oe-germany.de son aplicables y se suministrarán bajo pedido.

Designaciones, números de piezas originales, tipos de motores, características del vehículo u otros datos en relación con el motor, el vehículo o de otros fabricantes se citan únicamente para fines internos de comparación.

ОБЩАЯ ИНФОРМАЦИЯ:

Настоящим действительны общие условия заключения торговых сделок, опубликованные на www.oe-germany.de, либо они могут быть Вам предоставлены по запросу.

Обозначения, оригинальные номера, типы моторов, данные транспортных средств, либо другие данные производителей моторов, автомобилей приведены исключительно для сравнительных целей.



OE Germany Handels GmbH
Fritz-Müller-Straße 100-104
73730 Esslingen am Neckar | Germany

Phone +49 (0) 711 627 698-0
Fax +49 (0) 711 627 698-51

info@oe-germany.de
www.oe-germany.de

www.oe-germany.de



www.oe-germany.de

NEU!



Besuchen Sie unsere neue Website!
Visit our new website!
Visitez notre nouveau site web!
Visite nuestra nueva página web!
Посетите наш новый сайт!

www.webshop.oe-germany.de

NEU!

